

KING OF THE HAMMER II THUNDER SD USER MANUAL



Note

IMPORTANT

Please read the manual carefully and keep it in mind before using this machine.

Put this manual within touch of your reference in anytime.

1. Precautions

- What to check when you receive the product
- Note for installation
- Notes for transference

2. Specifications

3. Product Composition & Name of Each Part

- Composition
- Inside
- Inside of Hitting Plate

4. Sort of PCB and Circuit Diagram

5. How to Control and Set the Mode

6. Part List

7. Trouble Shooting & Maintenance

8. How to Assemble

9. Image

1. Precautions

Immediately after receiving the product

Make sure operating voltage and power consumption are the same as specifications of location. Incorrect use may cause malfunctions.

Notes for installation

A technician must install the product.
Please, follow the instructions carefully.

To avoid fire and electrical shock, use proper interior wiring and do not overload any one electrical outlet.

To avoid injury, do not expose the power cord to high traffic areas where it can be stepped and/or tripped on.

Notes for transference

When transferring the product, do not damage the power cord.
This could lead to a malfunction or accident.

To avoid sustaining damage to product and causing possible malfunction, package product tightly when transferring, as to not allow it to shift and/or move during transfer.



Power Requirement : 110V or 220V
Power Rating : 100W
Dimensions : W550 X D900 X H2350
Weight : 140Kg

□ Composition

- ① Front Door
- ② Hitting Plate
- ③ Urethane Hammer
- ④ Ticket Dispenser
- ⑤ Coin Box
- ⑥ FND
- ⑦ RGB Color Cluster
- ⑧ Second Coupling Device
- ⑨ Frame for fixing
- ⑩ Upper KEY
- ⑪ Billboard A'SSY



□ Inner Part

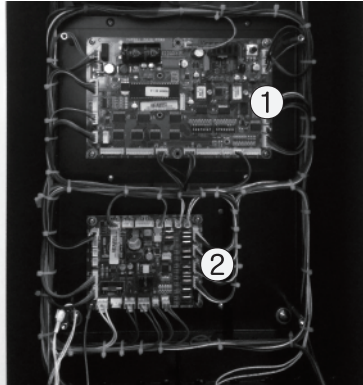

- ① Main PCB
- ② I/O PCB
- ③ FND PCB
- ④ RGB Color Cluster

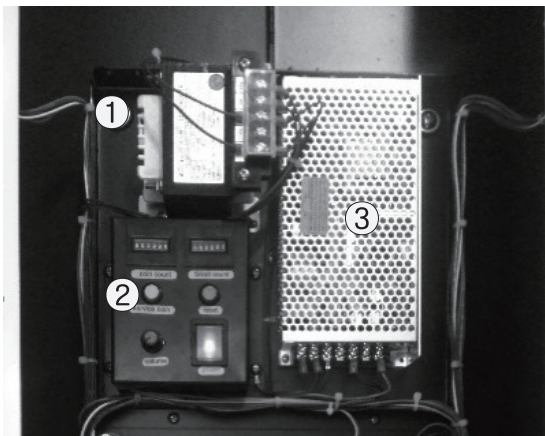

- ① Trans
- ② Counter and Sort of P/W & S/W
- ③ SMPS

□ Inside of Hitting Plate

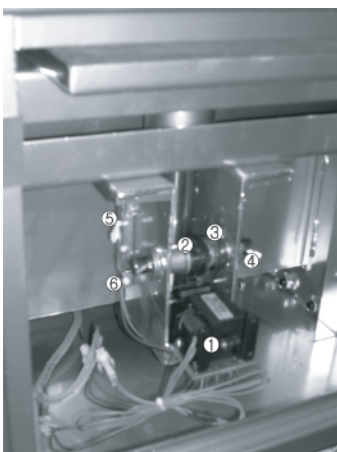

- ① Solenoid
- ② Processed part of \cap -shape
(Another name: grasshopper)
- ③ Small S.P
- ④ 15 \emptyset Pin
- ⑤ Position sensor
- ⑥ Speed sensor

KING OF THE HAMMER II
THUNDER SD Sort of PCB and Circuit Diagram

□ Main PCB

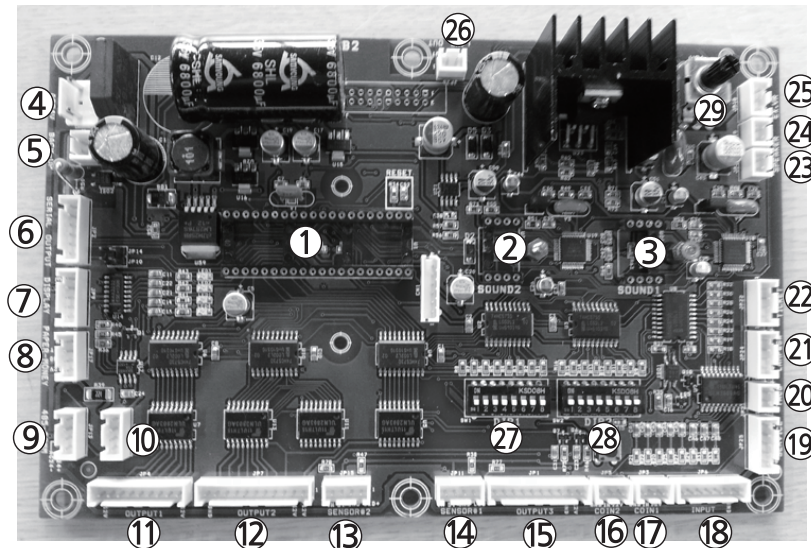

- | | | | | | |
|----------------------|--------------|---------------------|---------------------------------------|-----------------------|---------------------|
| 1. main ROM | 6. Coin FND | 11. not used | 16. Hammer Switch | 21. Ticket-out Button | 26. I/O Board Out 2 |
| 2. Sound ROM | 7. not used | 12. not used | 17. Coin | 22. Ticket-Dispenser | 27. Dip Switch |
| 3. Sound ROM(Effect) | 8. bill | 13. Position Sensor | 18. not used | 23. Speaker 1 | 28. Dip Switch |
| 4. AC24v | 9. I/O Board | 14. Speed Sensor | 19. Service Coin, Reset, Coin Counter | 24. Speaker 2 | 29. Not use |
| 5. AC220v(backup) | 10. not used | 15. not used | 20. Ticket Counter | 25. Volume | |

□ I/O PCB

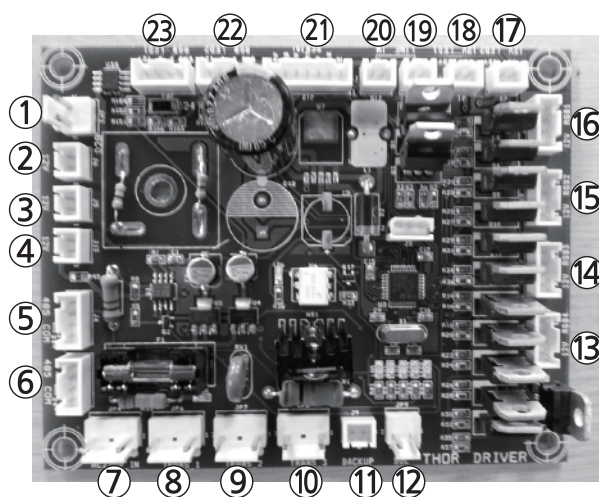

- | | | | | |
|--------------------|-------------------|---------------------------|---------------------|----------------|
| 1. DC 12V | 6. Score FND | 11. Not use | 16. RGB output | 21. Not use |
| 2. DC 12V | 7. AC 220V | 12. SOL | 17. Not use | 22. Not use |
| 3. DC 12V | 8. TRANS | 13. RGB output(Tower LED) | 18. Not use | 23 RGB Cluster |
| 4. DC 12C | 9. Woofer Speaker | 14. RGB output | 19. Speaker | |
| 5. I/O Board input | 10. Backup | 15. RGB output | 20. I/O board input | |

□ Main circuit diagram

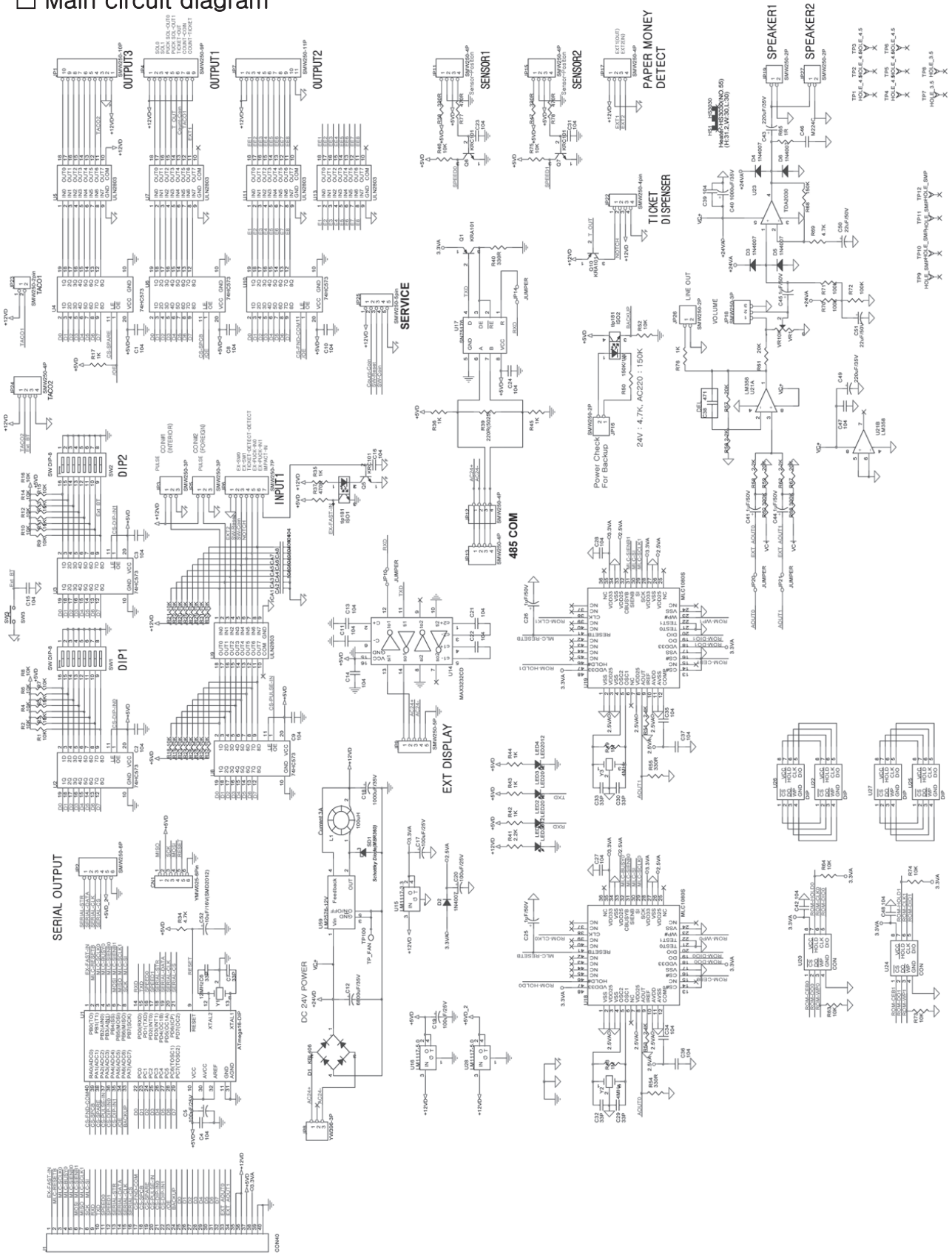

□ Drive(I/O) Circuit Diagram

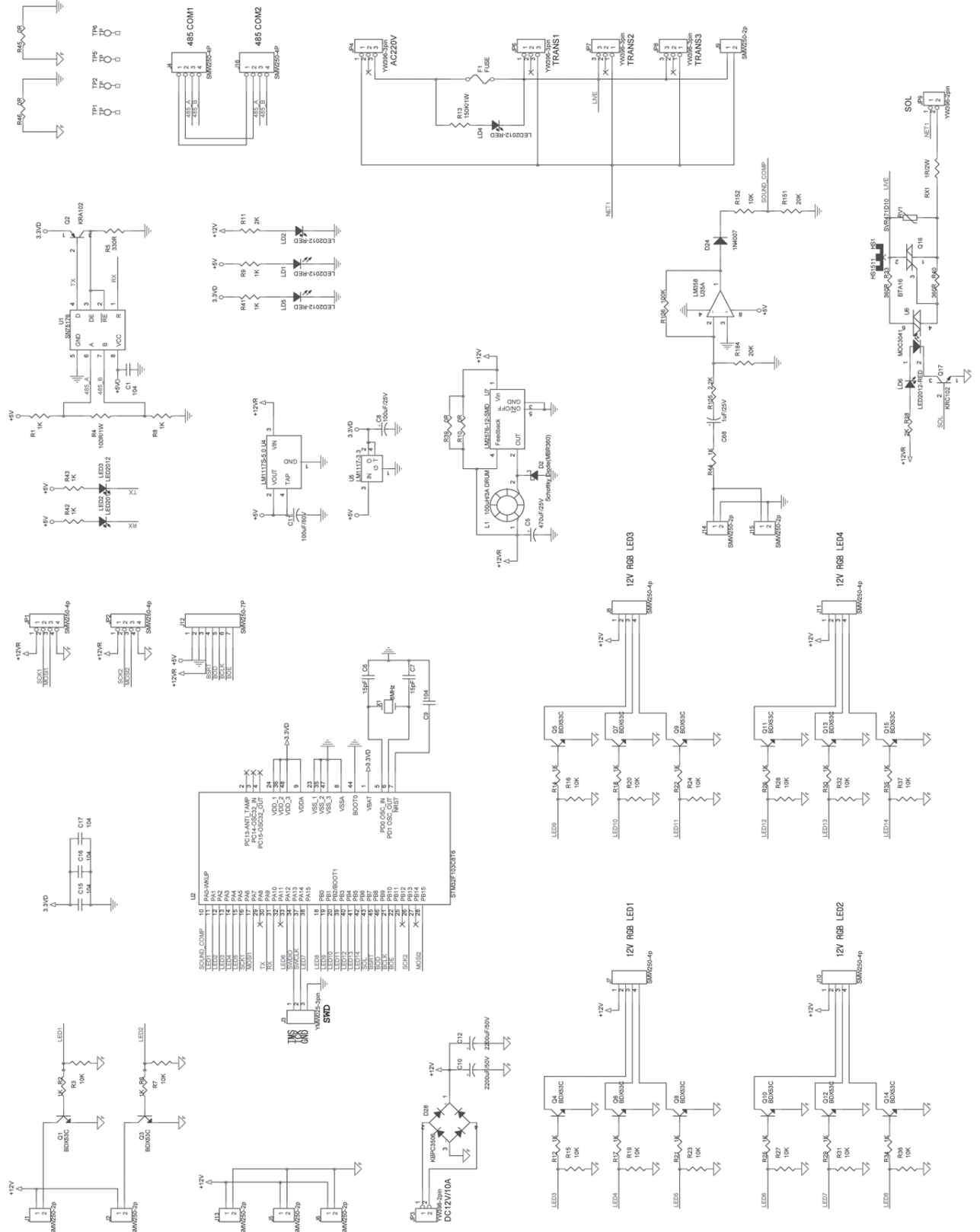

□ FND (I/O) Circuit Diagram)

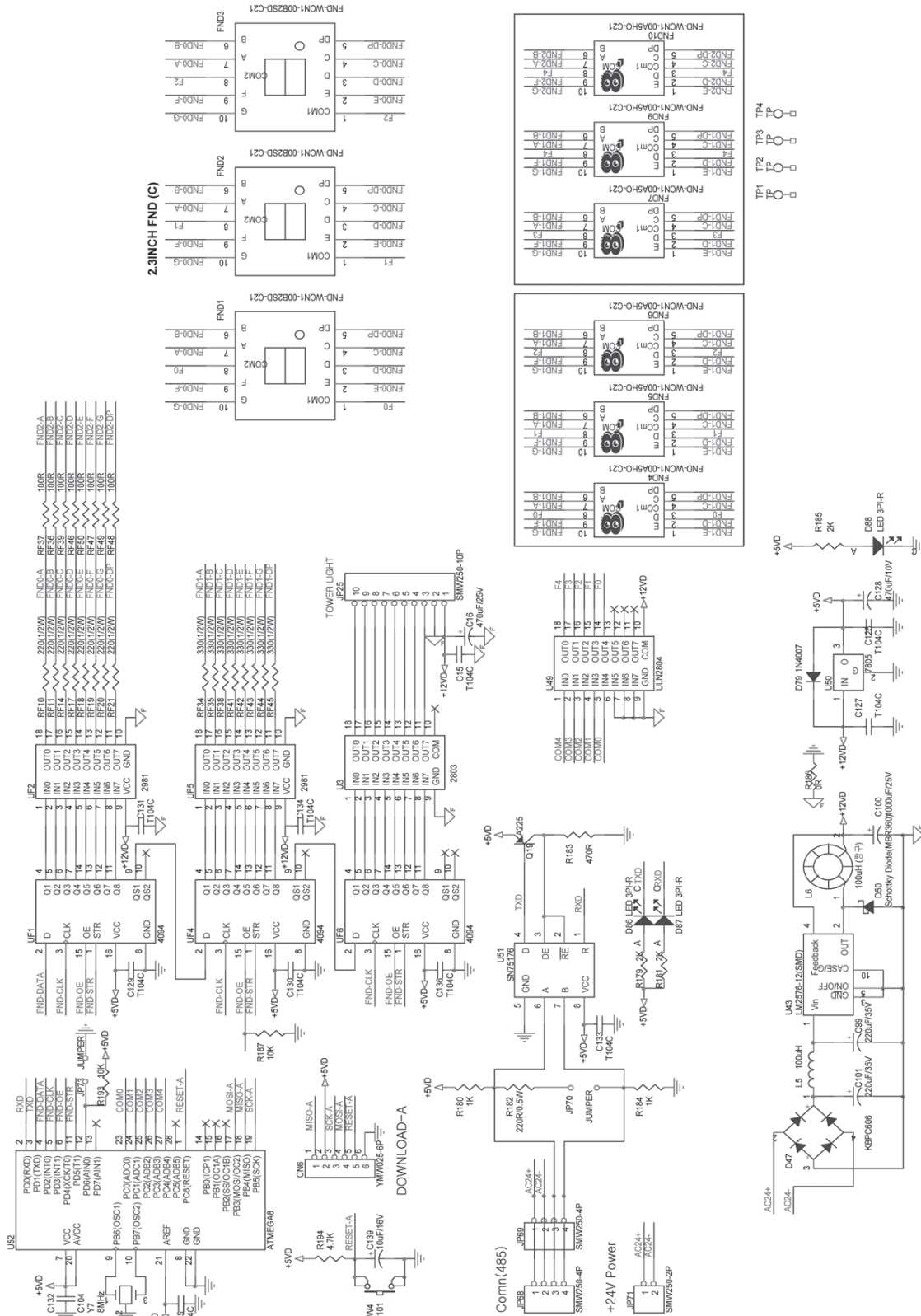

□ RGB Color Cluster

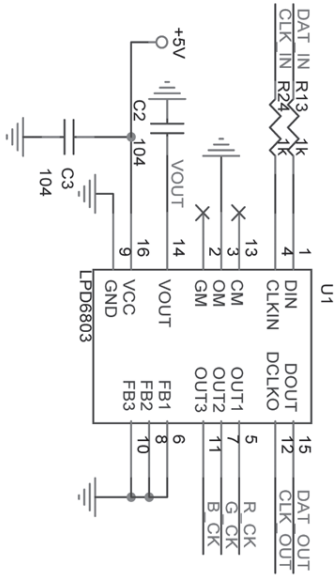
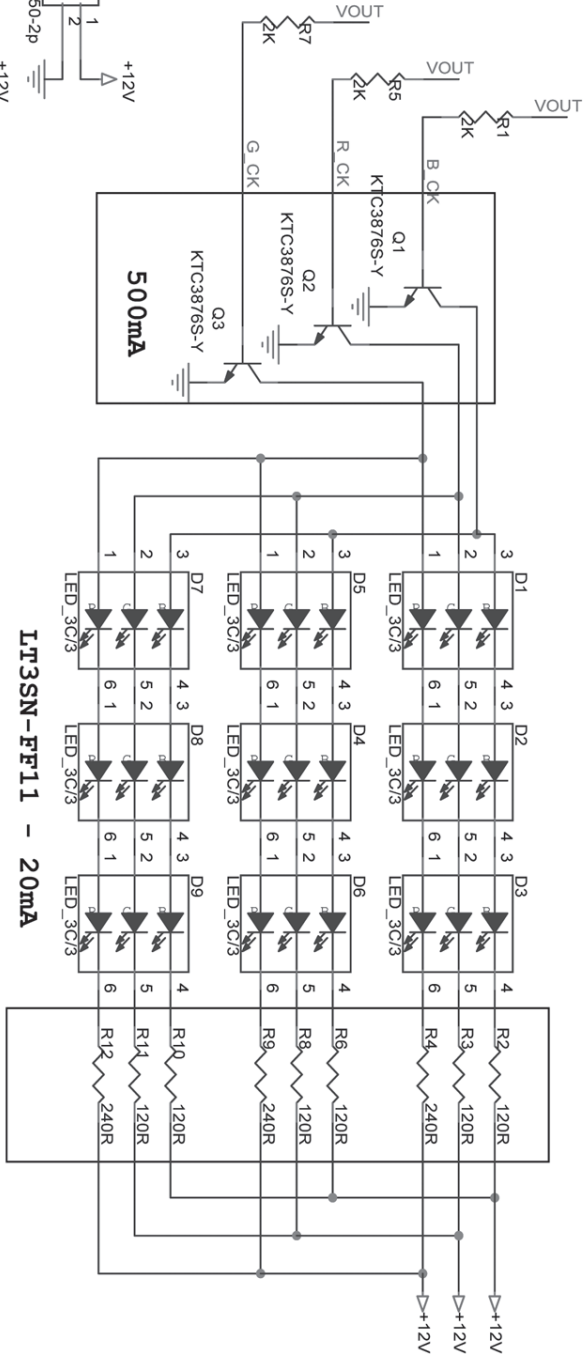
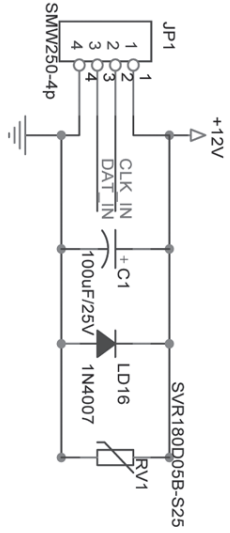
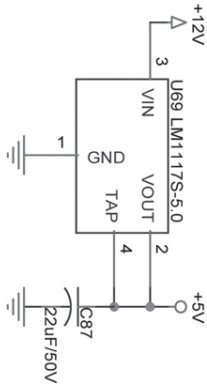

- TP1 HOLE_4 X
- TP2 HOLE_4 X
- TP3 HOLE_4 X
- TP4 HOLE_4 X
- TP5 HOLE_4 X
- TP6 HOLE_4 X

THUNDER SD (KING OF THE HAMMER SD II)ver.1.0									
DIP SWITCH 1		1	2	3	4	5	6	7	8
1COIN / 1CREDIT		OFF	OFF						
1COIN / 2CREDIT		ON	OFF						
2COIN / 1CREDIT		OFF	ON						
2COIN / 2CREDIT		ON	ON						
Free tickets	0			OFF	OFF				
	1			ON	OFF				
	2			OFF	ON				
	3			ON	ON				
Tickets per high score	0					OFF	OFF		
	5					ON	OFF		
	10					OFF	ON		
	15					ON	ON		
No function								OFF	OFF
Tickets at 777 score		10						ON	OFF
Tickets at 888 score		10						OFF	ON
Tickets at 999 score		10						ON	ON

DIP SWITCH 2		1	2	3	4	5	6	7	8
Back up		ON							
Demo Sound			ON						
Game over , in 30sec , if you don't hit the target				OFF					
Game over , in 60sec , if you don't hit the target				ON					
Bounce game per high score					OFF				
No bounce game per high score					ON				

* High score is deudcted by 1 every play

1) RGB Cluster



2) SENSOR SET

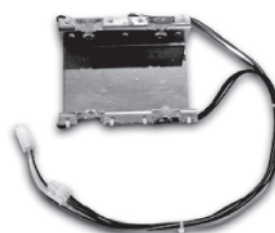

3) METAL HITTING PLATE



4) SHAFT



5) U - BAR



Part List

6)BIG SPRING



7)TEEAST BEARING



8)URETHANE
METALLIC MATERIAL GUARD

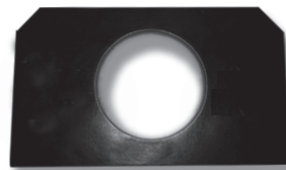

9)HAMMER



10)URETHANE RING

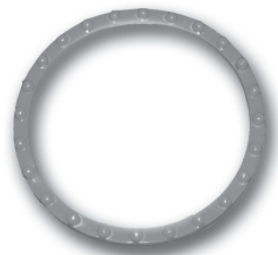

Part List

11)TRANS

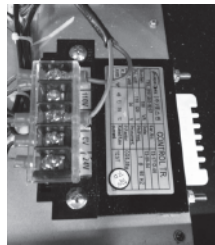

12)FRONT-PC



13)METEL HITTING URETHANE

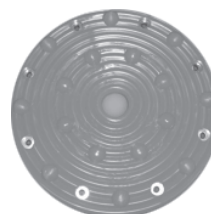

14)MAIN PCB

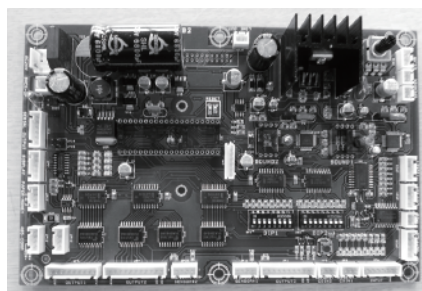

15)FND PCB (A)

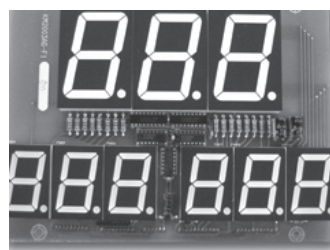

Part List

16) FND PCB (B)



17) I/O PCB

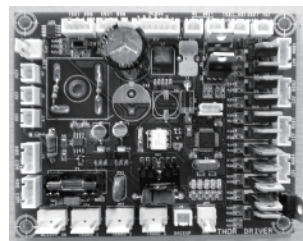

18) SMPS

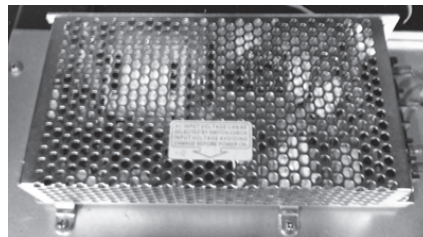

19) Frame for fixing

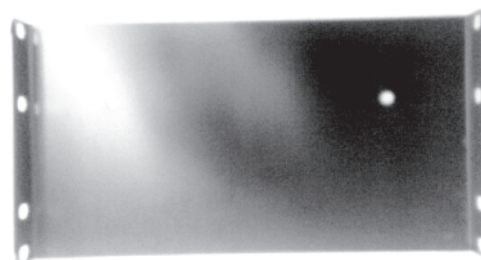

In case of loosening a screw bolt

Tighten a screw bolt by using 10mm lens tool once a week

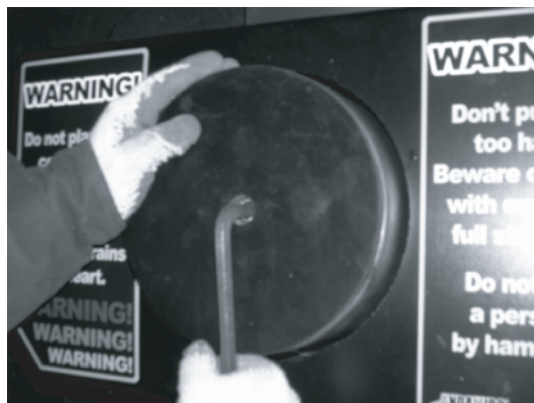

In case that the sensor is not checked

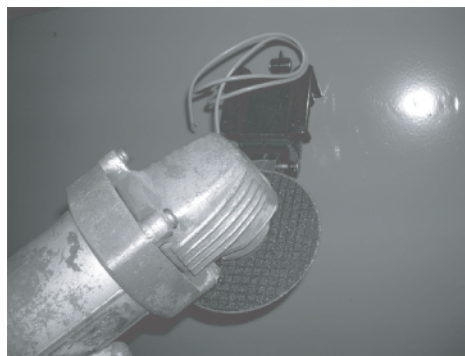
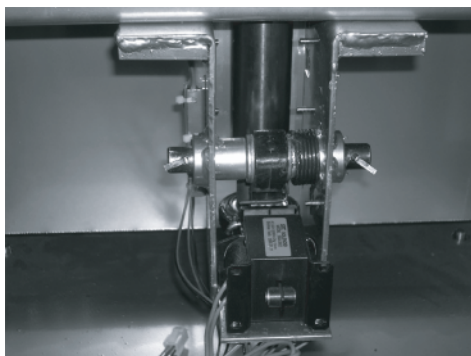

* Loosen Solenoid and S.P small-shaped part.

Grind processed part of \cap -shape with grinding tool such as a hand grinder.

When grinded too much, the Solenoid will not work well. Recommended grinding depth is approximately 1mm.

In case a hitting plate does not go up

* Solenoid works very well when a small amount of grease is applied on the processed part of \cap -shape.

In case of PCB problem

* Contact main office of manufacturer or the place of purchase.

① Full Body



② Binding steel plate

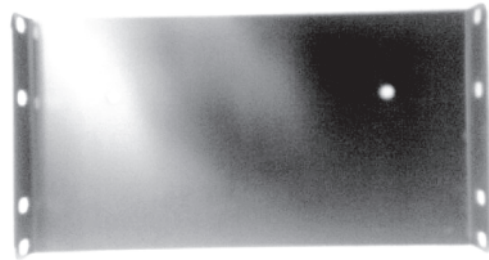

③ Hitting part

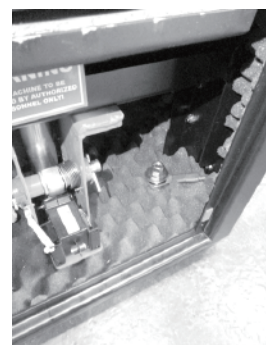
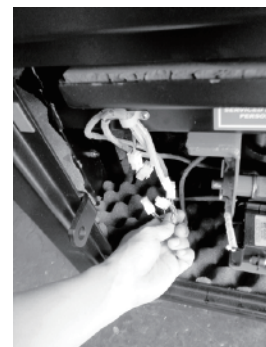

Meet positions of ① case and ③ hitting part and < Solenoid 2P, position sensor 3P, speed sensor 3P > interlink a connector.

Fix them by using 10EA of 12m screw bolt after covering ② binding steel plate.



Step. 1

Join Hitting part and Base body.
(12mm bolt, washer, spring washer)

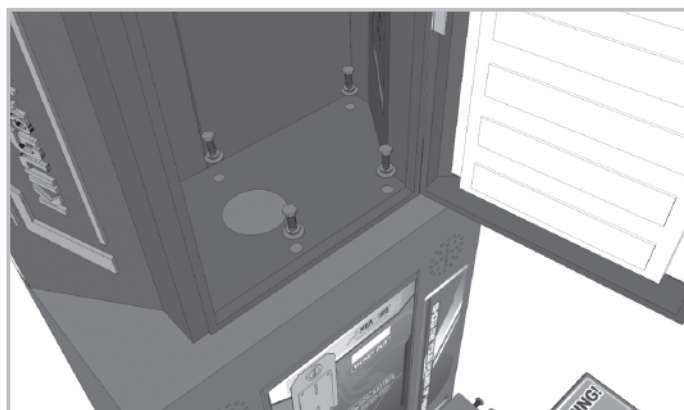

Step. 2

Join Upper body and Base body.
(10mm bolt, washer, Nylon nut)

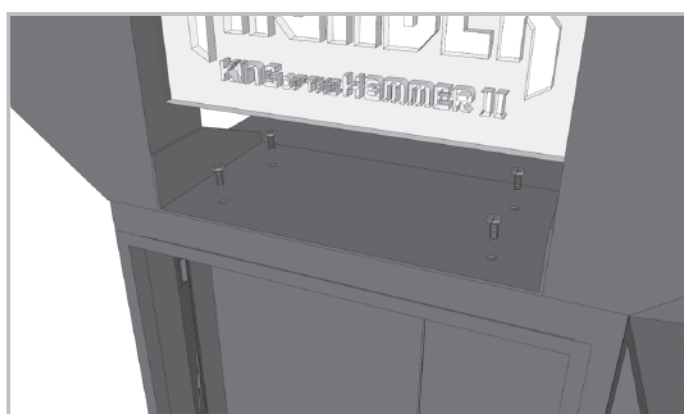

Step. 3

Join Tower and Upper body.
(4mm bolt, Nylon nut)



KING OF THE HAMMER II

THUNDER

SD

ANDAMIRO[®]
ENTERTAINMENT

ANDAMIRO CO.LTD(ANDAMIRO KOREA)
611-19,Changhang-dong, Ilsan-gu, Koyang-si,
Kyong gi-do, 411-380 Korea
TEL. 82-31-909-2121 / FAX. 82-31-908-7548
<http://www.andamiro.com>
e-mail: sales@andamiro.com

ANDAMIRO USA CORP(ANDAMIRO USA)
19140 S.VAN NESS AVE.TORRANCE,CA90501 USA
TEL: 310-782-3377 / FAX: 310-782-3360
Toll Free No: 1-866-ANDAMIRO
<http://www.andamirousa.com>
e-mail: sales@andamirousa.com